

Specialty Carbon Blacks for Superior Pigmented Inkjet Inks

Technical Information 1291

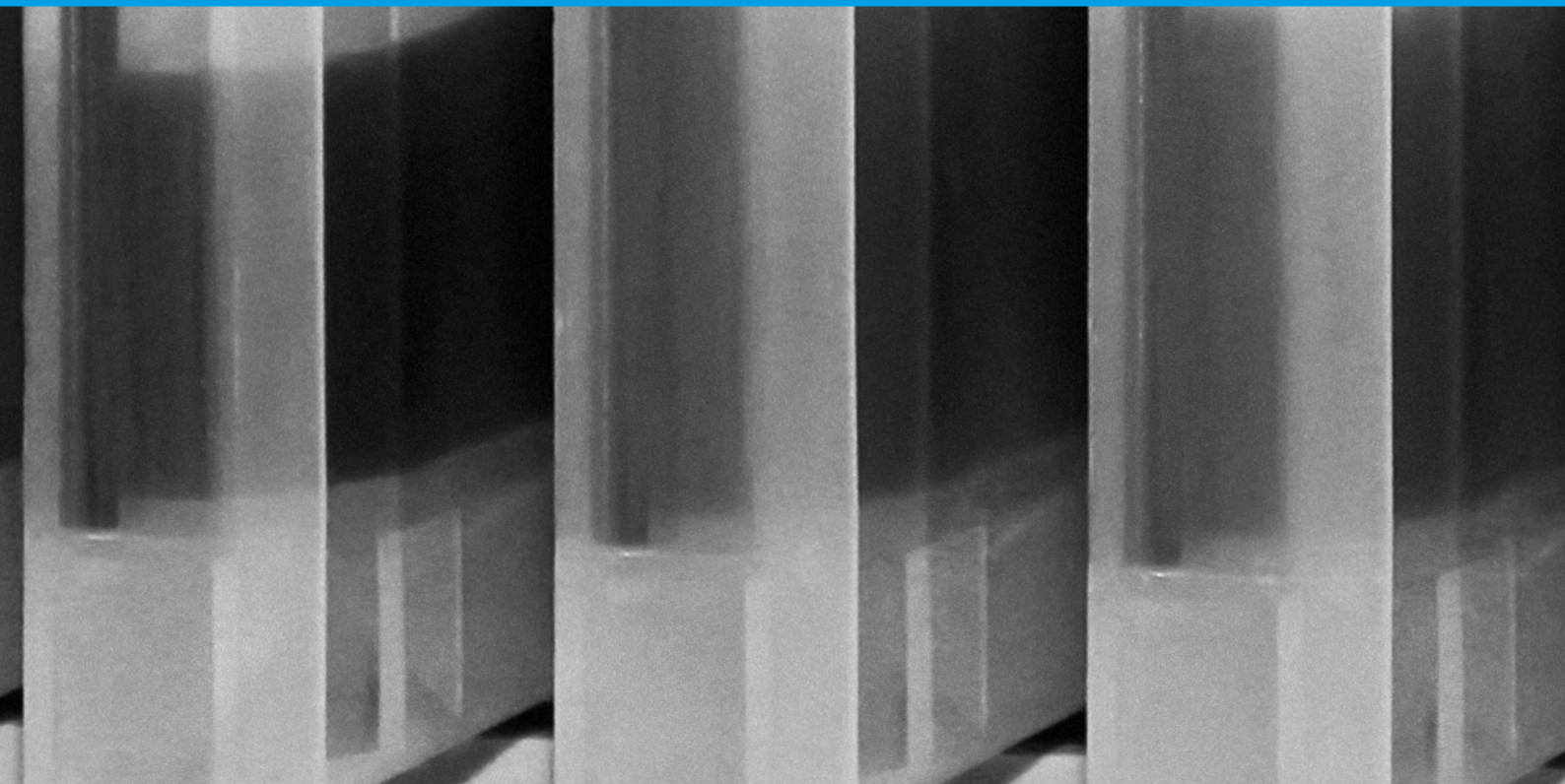

orion ENGINEERED
CARBONS
Focused. Innovative. Responsive.

Contents

1	Introduction	3
2	The Carbon Black Process	3
2.1	The Furnace Black Process	3
2.2	The Gas Black Process	4
2.3	Comparison between the Furnace Black and Gas Black Process	4
3	Specialty Carbon Black Product Portfolio for Inkjet Inks	5
3.1	NIPex® IQ Specialty Gas Blacks for Aqueous Inkjet Inks	5
3.2	Specialty Carbon Blacks for Non-Aqueous Inkjet Inks	6
4	Dispersion and Stabilization of Specialty Carbon Blacks	7
4.1	Dispersion Equipment	8
4.1.1	Dissolver	
4.1.2	Rotor-Stator	
4.1.3	Lab Dispersing Equipment	
4.1.4	Bead Mills/Agitator Ball Mills	
4.1.5	High-Pressure Dispersion Equipment	
4.2	Process of Specialty Carbon Black Dispersions and Final Inkjet Inks	10
5	Evaluation of Dispersibility and Optical Density	11
5.1	Particle Size	11
5.2	Storage Stability	12
5.3	Optical Density	13
6	Product Safety	15
7	References	15

1 Introduction

Pigment based inkjet inks have assumed leading market positions in desktop as well as wide-format inkjet printing since they provide outstanding light- and water-fastness as well as superior optical densities.

Among black pigments, Orion Engineered Carbon's Specialty Carbon Blacks have become the state of the art in inkjet ink pigments. Irrespective of the print head technology, they

allow the formulation of inkjet inks to meet the highest requirements in today's home, office and commercial inkjet printers.

The purpose of this Technical Information is to illustrate Orion Engineered Carbon's broad range of NIPex® Specialty Carbon Black powders and to provide the formulator with the essential information for the successful development of technically and commercially superior inkjet inks.

2 The Carbon Black Process

Specialty Carbon Blacks are manufactured by the partial combustion of hydrocarbons to form individual Carbon Black particles. The conditions in the process are such that the newly created particles collide and fuse together within fractions of a second. This results in the formation of branched, chain-like aggregates with a size above 100 nm. The aggregates are the smallest dispersible unit of a Specialty Carbon Black (**Figure 1**). The aggregates, via mechanical entanglement, form loose collections of larger structures commonly referred to as agglomerates. In contrast to the sub-micron size of the aggregates, the more friable agglomerate structure can range in size from one to several hundred microns.

Since agglomerates are only bound through weak forces, they are easily broken down by shear forces during processing, so that the aggregates are the dominant particle species in an ink formulation.

Figure 1

Scanning electron microscopic image of a Carbon Black aggregate (120,000x magnification).

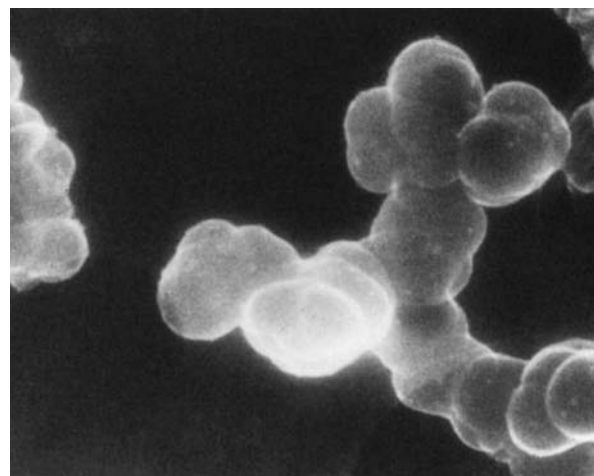

2.1 The Furnace Black Process

The Furnace Black process (**Figure 2**) uses liquid hydrocarbons as feedstock. The feedstock is injected into a refractory-lined furnace, which is heated by the combustion of natural gas and pre-heated air.

After the Specialty Carbon Black is formed, it is quenched by water, cooled down and separated from the gas stream. The main advantage of the Furnace Black manufacturing

process is its flexibility to tailor Carbon Black properties such as average primary particle size (between 10 and 80 nm), degree of aggregation, aggregate size distribution, and porosity. Furnace Blacks usually carry a small amount of basic functional groups on their surface and therefore exhibit a hydrophobic, non-polar character, along with a pH value above 7. Post-oxidation processes allow tailored modification of these surface characteristics.

Figure 2

Schematic Depiction of the Furnace Black Manufacturing Process.

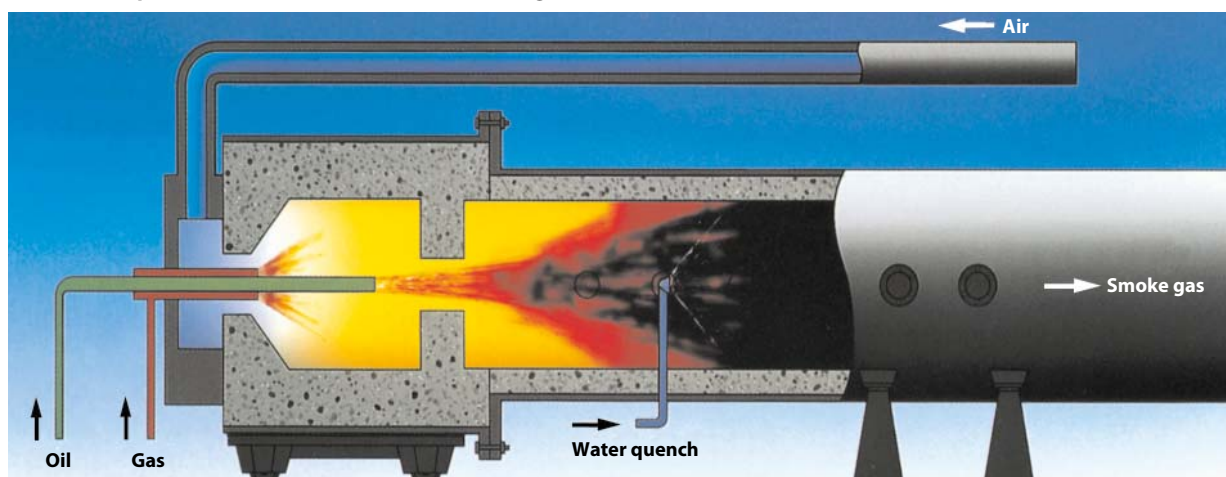

2.2 The Gas Black Process¹⁾

The Gas Black process (Figure 3) derives its name from the fact that the feedstock is vaporized and fed to the combustion chamber by means of a carrier gas. This vaporization step prevents the contamination of the Specialty Carbon Black with feedstock residues and results in a low ash product. During the burning phase, the presence of oxygen ensures a high degree of oxygen-functional groups on the pigment surface. These polar groups account for the acidic

pH range of all Gas Blacks. Some of the important properties of Gas Blacks are:

- Primary particle size between 10 and 30 nm
- Narrow primary particle and aggregate size distribution
- High purity
- Very high structure that is easily dispersed

Figure 3
Schematic Depiction of the Degussa Gas Black Process.

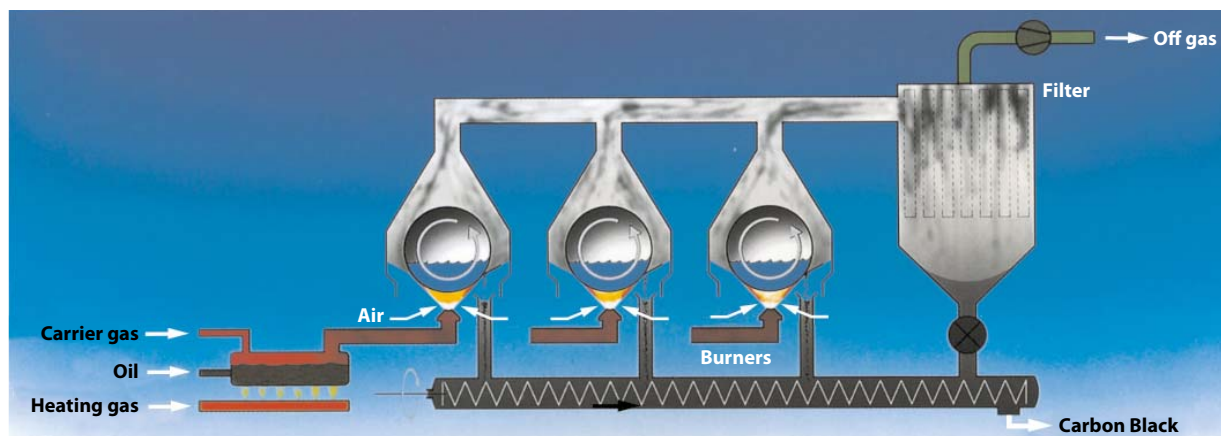

2.3 Comparison between the Furnace Black and Gas Black Process¹⁾

The key differences of Specialty Carbon Blacks produced by the Furnace Black and Gas Black processes are summarized in Figure 4.

Figure 4
Key Differences between Furnace Blacks and Gas Blacks.

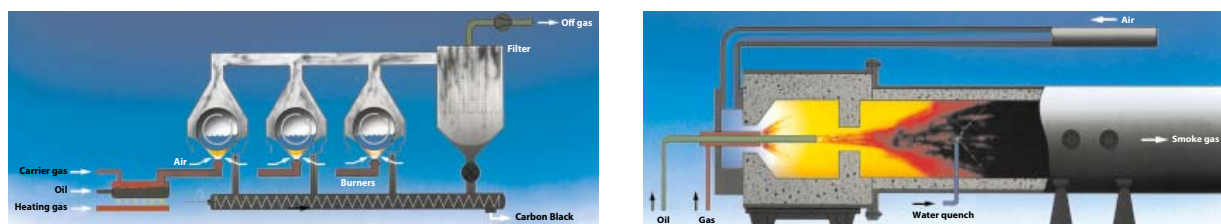

Gas Black Process	Process	Furnace Black Process
Open oxidizing atmosphere	Process	Closed reducing atmosphere
Very high but loose structure	Structure	Variable
Many acidic groups	Surface oxides	Few basic groups
Acidic (3.5 – 4.5)	pH value	Basic (8 – 10)
Hydrophilic, polar	Water wettability	Hydrophobic, non-polar

Examples of oxygen-functional groups on the Carbon Black surface which can be created in the two different Carbon Black processes depicted in Figure 5.

¹⁾ according to the Degussa Gas Black Process

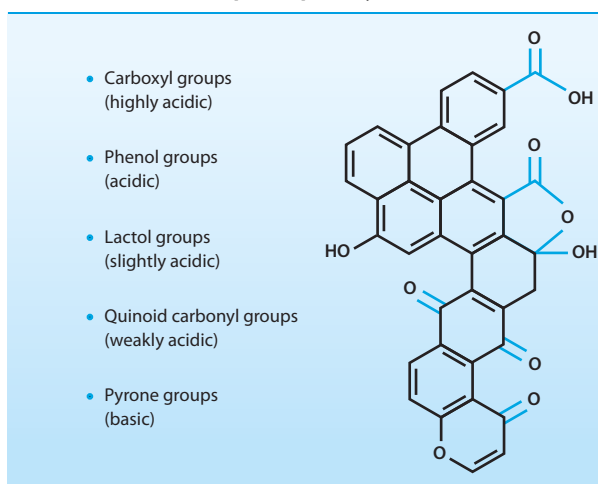
Figure 5**Surface functional Groups on Specialty Carbon Black**

Predominantly, acid groups are formed on the Gas Black particle surface due to the presence of ambient air during the burning phase of the Gas Black process. In contrast, only a few surface oxides are formed on the Furnace Black particle surface. These particles are predominantly basic in character due to the Furnace Black process being closed and void of excess oxygen. Orion Engineered Carbons offers a broad range of Specialty Carbon Black grades produced by both processes. This enables us to supply Specialty Carbon Blacks with tailored surfaces for individual requirements. Hydrophilic grades with polar surface properties, for example, are especially suitable pigments for water-based inkjet inks while hydrophobic products are preferred for non-polar solvent based inks.

3 Specialty Carbon Black Product Portfolio for Inkjet Inks

3.1 NIPex® IQ Specialty Gas Blacks for Aqueous Inkjet Inks

Orion Engineered Carbons' Specialty Carbon Blacks, produced by its unique Gas Black process and marketed under the tradename NIPex® IQ, are the preferred choice for water-based inkjet inks. Due to their high structure and surface polarity, Gas Blacks re-agglomerate while the ink is drying and form large network-like agglomerates on the substrate, making them well-suited for printing on plain paper. The re-agglomeration limits pigment penetration into the substrate and is the key factor for the outstanding optical densities. Additionally, our NIPex® IQ grades meet the highest demands of the inkjet industry regarding quality and purity (see also Table 1).

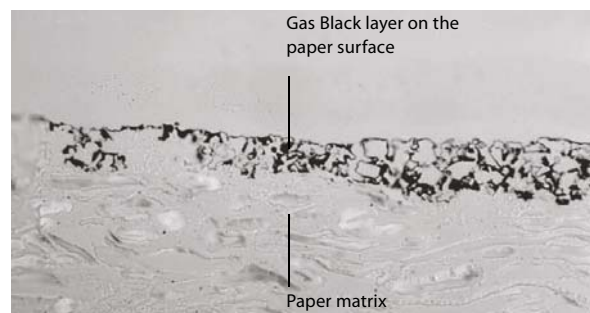
Figure 6**Transmission Electron Microscopic Image (microtome Section) of plain Paper printed with a Gas Black-based Inkjet Ink****Table 1****Benefits of NIPex® IQ Gas Blacks in Inkjet Printing**

Gas Black Properties	Application Benefits
High concentration of oxygen-functional surface groups	Good wettability and easy dispersability in water and other polar media
High degree of purity	Minimizes corrosion and deposits on the print head, better colloidal stability
High but loose structure	Easy dispersability
Pigment aggregates can agglomerate to form a larger network structure	Prevents pigment penetration into porous printing media resulting in high optical density values

In the case of non-oxidized Furnace Blacks, the degree of oxidation is usually <1.5%, in the case of non-post-oxidized Gas Blacks it is in the range of 4 to 6%. As a result of post-oxidation, the degree of oxidation can be raised up to >20% in the case of Gas Blacks.

Figure 7

Overview about Orion Engineered Carbons' Specialty Carbon Blacks for Inkjet Inks

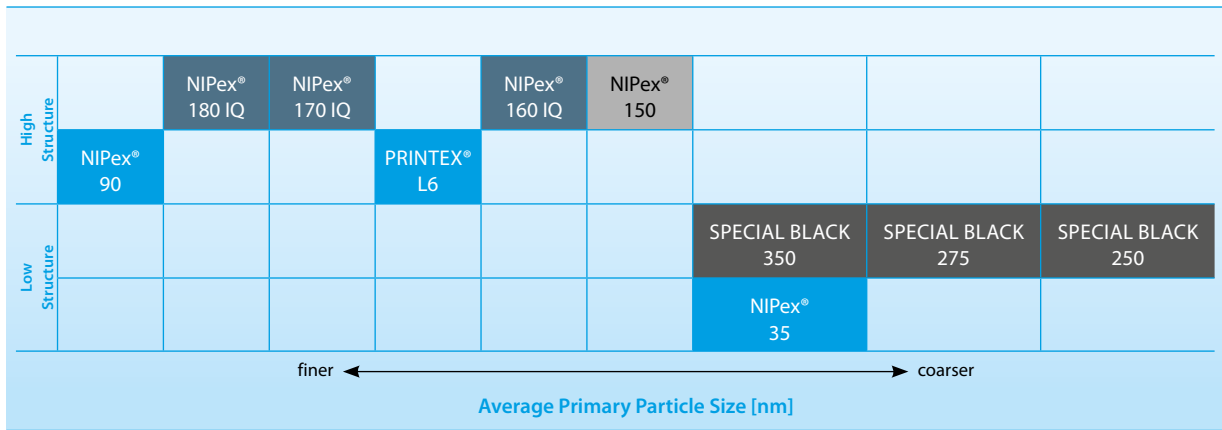

■ Furnace Black ■ Oxidized Furnace Black ■ Gas Black ■ Oxidized Gas Black

The Gas Blacks NIPex® 160 IQ, NIPex® 170 IQ and NIPex® 180 IQ are manufactured as described in chapter 2.2 without a subsequent post-treatment. They differ from each other in their mean primary particle sizes and specific surface areas. They are the first choice when developing

a new water-based inkjet ink formulation. The high purity combined with the high structure provides excellent printability and high optical density especially on plain paper.

3.2 Specialty Carbon Blacks for Non-Aqueous Inkjet Inks

Our portfolio of Specialty Carbon Blacks contains selected Furnace and Gas Blacks which are useful for special inkjet ink formulations based on non-polar or moderately polar ink vehicles and solvents.

NIPex® 150

NIPex® 150 is an easily dispersible, post-oxidized Gas Black which is tailored for inkjet inks with very low viscosities and fine particle sizes. This product typically requires low levels of dispersants in water due to its high degree of surface groups.

NIPex® 90

NIPex® 90 is a non-oxidized, highly structured Furnace Black with superior dispersion properties. The very small primary particle size enables very high optical densities and particle fineness.

PRINTEX® L6

PRINTEX® L6 is a non-oxidized Furnace Black with very high structure for outstanding optical densities. Additionally, PRINTEX® L6 is useful in inkjet inks providing high electrical conductivity.

SPECIAL BLACK 350, SPECIAL BLACK 275 and SPECIAL BLACK 250

Both types of Furnace Blacks are characterized by a comparably low UV absorptivity and are especially suited for UV curing inkjet inks. Their low structures and oxidized pigment surface result in low viscosity of the final inkjet ink.

NIPex® 35

NIPex® 35 is a non-oxidized Furnace Black with very low structure which allows the development of high pigment loading preparation with low viscosities.

An overview of Orion Engineered Carbons' Specialty Carbon Blacks for inkjet inks is given in Figure 7. Additionally, a broad range of other Specialty Carbon Black grades is available which mainly differ in primary particle size, degree of oxidation, porosity and structure. Detailed information about these Specialty Carbon Black grades is described in Orion Engineered Carbons' brochure "What is Carbon Black".

Beside these commercial products, Orion Engineered Carbons consistently develops novel Specialty Carbon Black grades (XPB) tailored to meet the needs of modern inkjet ink manufacturers. Product samples are available on request.

4 Dispersion and Stabilization of Specialty Carbon Blacks

The proper dispersion of a Specialty Carbon Black is the most challenging step in producing a high quality inkjet ink. Orion Engineered Carbons has extensive experience and in-depth knowledge of dispersing technologies and colloidal chemistry essential to produce stable, dispersed particles. Our goal is to apply our expertise to assist our customers in producing superior inkjet inks.

The dispersion process can be divided into three steps:

- a Wetting of the pigment particles
- b Milling/breaking-down of the agglomerates
- c Stabilization of the aggregates

Wetting is the creation of surface contact between the ink medium (solvent) and pigment. This process can be accelerated by the addition of wetting agents (dispersants) to lower the surface tension of the medium and facilitate spreading the medium onto the pigment surface.

In the next step, cohesive forces within the pigment particle must be overcome to break down the agglomerates into aggregates. This can be accomplished using high energy processing, such as crushing, shear or impact (see chapter 4.1). These mechanical forces are generally sufficient to get the aggregate level, however, they are not high enough to break down the aggregates to primary particles.

In order to stabilize the aggregates dispersed in the ink medium, surface-active substances (dispersants) are typically required. These dispersion additives selectively prevent re-agglomeration of the pigment particles. The potential disadvantage of dispersants is their negative impact on important ink properties.

The key to developing a successful dispersion is the stabilization method employed. The following methods are frequently used for pigment stabilization in inkjet inks:

- Electrostatic stabilization
- Sterical stabilization

Electrostatic stabilization is based on the adsorption of ionic dispersion additives at the Carbon Black surface. This creates a charged double layer and causes the charged pigment particles to develop strong electrostatic repulsive forces between one another. Excellent results can be obtained with dyes as the function of anionic dispersant, an area where Orion Engineered Carbons has strong know-how and experience.

Steric stabilization results from the adsorption of Polymeric and/or non-ionic dispersion additives at the surface of a Carbon Black. This creates a barrier or "separator" between pigment particles that prevents re-agglomeration. In inkjet inks, Polymer molecules are predominantly used for steric stabilization.

The trend in inkjet print-head technology is towards smaller droplets, which requires print-head nozzles with diameters of just a few micrometers. Prevention of nozzle clog-

Table 2

Advantages and Disadvantages of electrostatic and sterical Stabilization of Specialty Carbon Blacks for use in Inkjet Inks

	Benefits	Weaknesses
Electrostatic Stabilization	<ul style="list-style-type: none"> • High stability • Reduced tendency to foam 	<ul style="list-style-type: none"> • pH dependence on the ionic strength • Reduction of the surface tension • Dispersion instability in the presence of multivalent cations
Sterical Stabilization	<ul style="list-style-type: none"> • Improved adhesion properties • Good compatibility with ink additives 	<ul style="list-style-type: none"> • Tendency to foam • High viscosities • Ink encrustation of the inkjet printer nozzles and/or deposits in the print head

Figure 8

Ink Encrustation of Inkjet Printer Nozzles.

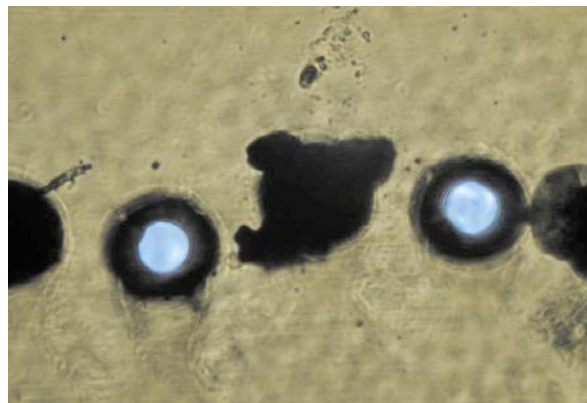

Figure 9

Deposits in the Ink Supply to the Print Head Heat Elements.



ging and deposits on the print-head is essential to ensure long-term print reliability. Particle fineness of the pigment, purity of ink ingredients and long term stability of the ink dispersion are necessary requirements. A key role is hereby played by the Specialty Carbon Blacks which need to fulfill the following requirements:

- Excellent dispersability and dispersion stability in ink solvents

4.1 Dispersion Equipment

As explained in the previous chapter, the agglomerates of Specialty Carbon Blacks can be efficiently broken up by shear, crushing or impact. Type and intensity of the respective force depends on the dispersion equipment used.

Shear occurs when forces exerted on a large agglomerate have opposing directions as a result of, for example, different flow speeds of the surrounding medium. If the shear force is high enough to overcome the adhesion energy within the agglomerate, it will rupture (process A in **Figure 10**).

Crushing takes place when an agglomerate is broken down between colliding or grinding elements (process B). The term impact is used if the agglomerate collides against the wall of the vessel, a grinding element or another particle and breaks up as a result of this collision (process C).

Usually, a large portion of the energy supplied to the system is dissipated in the form of heat, so efficient temperature control and cooling is recommended during pigment dispersion.

Figure 10

Processes used to break down Specialty Carbon Black Agglomerates into Aggregates: A Shear, B Crushing and C Impact

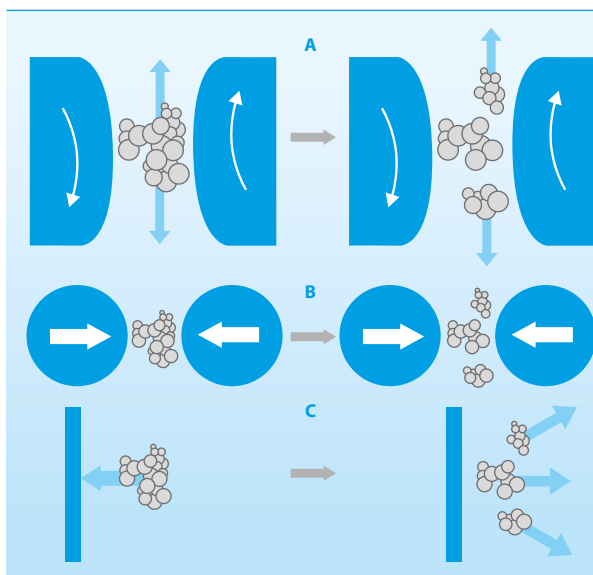

- High optical density on uncoated and coated substrates
- High purity

The dispersibility of a Carbon Black is strongly influenced by its primary particle size, structure, porosity and amount of surface oxides as summarized in **Figure 10**. Specialty Carbon Blacks with large primary particles, high structure and porosity and a high number of surface oxides are the most easily dispersible products.

4.1.1 Dissolver

The action of the dissolver depends mainly on shear as a result of speed. The dissolver is the weakest dispersion device in the series described here. The following conditions should be fulfilled to obtain an optimum result (see also **Figure 11**):

- A peripheral speed of the disk of 18 – 25 m/s
- The diameter of the vessel should be 2 – 3 times larger than the diameter of the disk
- The distance the dispersion disk from the base of the vessel should be 0.5 – 1 times the diameter of the disk.

4.1.2 Rotor-Stator

The dispersion of pigments by means of a rotor-stator is also primarily based on shear.

Figure 11

Optimum Geometry for a Dissolver Disk (left) and Photograph of a Dissolver Disk (right).

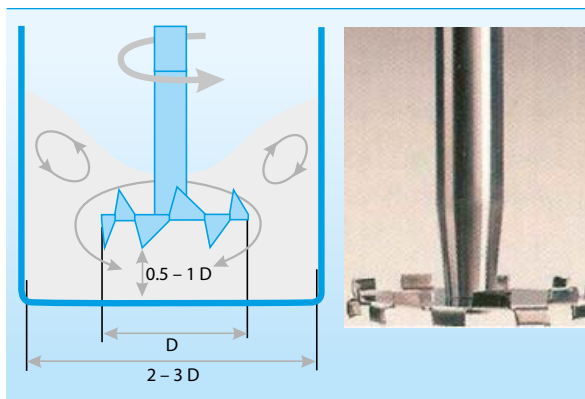

Figure 12

Schematic Depiction of the Dispersion Process by means of a Rotor-stator Stirrer (left). Rotor-stators from two different Manufacturers (middle and right)



During the dispersion process, liquid and pigment particles are inducted between the stationary stator disk (Figure 12, left picture; depicted in grey) and the rotating rotor disk inside the rotor-stator stirrer depicted (in blue). The narrow gap between rotor and stator, combined with the high rotating speed of the rotor, results in high shear forces. This shearing energy can be controlled by varying the speed of rotation.

4.1.3 Lab Dispersing Equipment

Ultrasonic dispersers with high power (>500 Watt) are often used for lab screening tests to prepare small quantities of Specialty Carbon Black dispersions. The mechanism of ultrasonic dispersers is also based on the shear principle. The forces necessary for the dissociation of the particles are produced by pressure differences.

An ultrasonic unit consists of a sound generator, sound transducer and sonotrode. The generator produces electrical vibrations in the ultrasonic range (> 20,000 vibrations/min), which are converted by the transducer into mechanical vibrations. Depending on equipment, the high energy input can lead to pronounced warming of the sample. A drawback of ultrasonic dispersion is the noise and the wear of the sonotrode which limits the use in production scale.

Figure 13

Typical Laboratory Dispersing Equipment: Shaking Mixer Skandex (A) and Ultra Sound Dispersion Equipment (B)



Shaking mixers are devices in which the dispersion mixture is subjected to intensive shaking in a closed container. Grinding elements, usually in the form of beads, are added to the mixture to increase the input of energy. Agglomerates are thus broken down by shear, impact and crushing.

Shaker mixers allow the preparation of high quality dispersions but the method is restricted to laboratory use.

4.1.4 Bead Mills/Agitator Ball Mills

Bead mills and agitator ball mills are similar types of equipment.

The cylindrical or conical agitator chamber consists of the agitator shaft with grinding disks. The mill chamber contains the material to be milled and the grinding beads, which are set in motion by the rotation of the agitator shaft, causing the pigment agglomerates to be broken up (Figure 15). The bulk of the dispersion work is achieved by shearing in the immediate vicinity of the agitating elements. A separating device holds the grinding beads in the mill and redirects them via a channel to the inlet of the mill chamber.

Figure 14

Bead mill



Today's modern bead mills are available in various sizes and configurations such as horizontal or vertical operating positions, different types of agitators/stators, bead separators and cooling systems which enables the selection of tailored wet-grinding technology. The number of variable parameters is large and it is necessary to optimize them for good grinding results:

- Operating parameters such as agitator speed, throughput, filling rate of the beads, single or multi-pass or circulation process
- Design, material and size of the bead mill
- Grinding elements such as type, size, etc.
- Ratio of cooling surface to volume of mill chamber
- Separation technology of grinding elements
- Composition of formulation, such as solid content, liquid medium, dispersants or additives to optimize viscosity and surface tension, and additives to minimize the risk of crusting and foaming during grinding process.

4.1.5 High-Pressure Dispersion Equipment

In the late 1980's, the first patent was published reporting the dispersion of a pigmented ink-jet ink by passing through at least a plurality of nozzles within a liquid jet interaction chamber at a liquid pressure of at least 1,000 psi. During processing, the product stream accelerates to very high velocities, creating shear rates of much higher magnitude. Such dispersion equipment as described above is supplied by Micro-fluidics under the tradename Microfluidizers.

Microfluidizers are offered with pressure ranges up to 40,000 psi. An array of nozzles allow the jetting of liquid streams, directed towards each other and at high veloci-

ties. The high energy particle collisions that occur result in dispersions having a narrow distribution of very fine particles. Alternative high-pressure homogenizers operate by pushing dispersions through variable geometry spring loaded valves at high pressures (up to 15,000 psi). Such homogenizers are also often used for milk homogenization at 2,000 to 3,000 psi. Their main drawback is the limitation of process pressure as well as the spring-loaded valve which does not allow precise particle size control.

The main advantages of high-pressure dispersion equipment include:

- Very effective dispersing method to obtain small Carbon Black aggregates
- Fast processing times
- Control of energy input by process pressure
- Reduced contamination (absence of bead abrasion)
- Very low batch to batch process variation

4.2 Manufacturing Process of Specialty Carbon Black Dispersions and Final Inkjet Inks

Although pigment dispersions can be produced with different dispersing equipment, bead mills are most commonly used for manufacturing Specialty Carbon Black dispersions.

Generally, it is recommended to manufacture a Specialty Carbon Black dispersion for an inkjet ink using the following four process steps (Figure 15):

Step 1: Pre-Dispersion

It is highly recommended to mill the pigment preparation with high pigment loading. This reduces the risk of contaminating the milled pigment dispersion through bead abrasion and increases the milling energy input into the product. Usually Gas Blacks can be milled with a pigment loading of about 25 – 30% by weight depending on the pigment surface, dispersing agents and surface chemistry.

Figure 15

Process Steps to prepare a Specialty Carbon Black Dispersion for Inkjet Inks.



- 1 Pre-dispersion
- 2 Grinding
- 3 Dilution
- 4 Filtration
- 4a Filtration

De-ionized water and all other components except Carbon Black are filled into the vessel. Carbon Black is slowly added while stirring with a dissolver or rotor-stator at low rpm. Once the Carbon Black is completely wetted out, the speed of the dissolver is increased until optimum homogenization is obtained. Mixing time with the dissolver is typically 20 minutes or more.

To prevent evaporation of water and/or solvents and hence crusting of the mill base, it is recommended to cover all containers during the pre-dispersion process.

Step 2: Grinding Process

The grinding process should be carried out in a closed media mill in recirculation mode. Therefore the milling base prepared in step 1 is pumped through the media mill and back to the container with high velocity of circulation. Depending on the efficiency of the media mill and the dispersion composition, the grinding process is usually best carried out with a specific grinding energy in the range of 100 – 300 kWh/t. The grinding quality of the dispersion can be determined by a light microscope at 200 to 500 fold magnification. Grinding is completed if no particles bigger than 1 µm can be detected in the dispersion. If larger particles are still present in the dispersion, the milling process should be continued. The bead mill should meet the following criteria:

- Grinding media: 0.3 mm to maximum 1.0 mm
- Grinding media material: Zirconium oxide (preferably Yttrium doped Zirconium oxide)
- Rotor and stator material: lowest possible abrasive properties

Step 3: Dilution of the Mill Base

After preparation of the mill base in step 2, the pigment dispersion is diluted to the final inkjet ink in a separate container. Before starting the dilution process the Specialty Carbon Black content of the mill base should be deter-

Figure 16

Dilution of the Mill Base to the final Dispersion and/or Inkjet Ink: Improper (left) and correct Process (right) to prevent Dispersion Shock

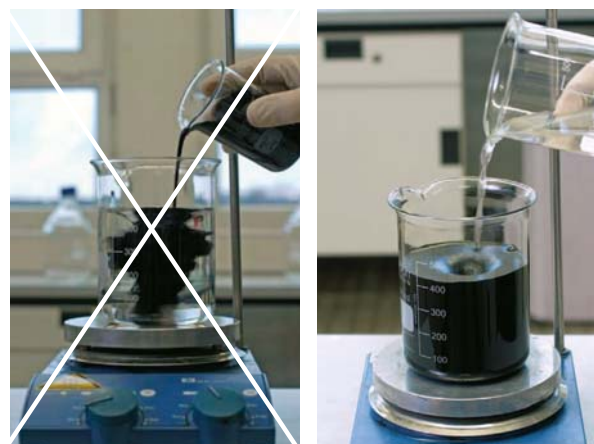

mined to enable an accurate adjustment of the pigment loading in the final inkjet ink.

Parallely a premix is prepared containing all other dispersion and/or ink additives. This additive mixture is then slowly and carefully added to the mill base by stirring with a propeller mixer. It is critical to prevent a “dispersion shock” during the dilution step which may cause pigment flocculation. Therefore it is highly recommended to add the additive premix into the pigment concentrate and not the other way around as shown in Figure 16.

Step 4: Filtration of Pigment Dispersion and/or Final Inkjet Ink

High efficiency polypropylene filters from 0.3 to 1.0 µm fineness are recommended to filter pigment dispersions and final pigmented inkjet inks. The main objective of the filtration step is to remove large particles and enable maximum print performance.

5 Evaluation of Dispersibility and Optical Density

5.1 Particle size

Examination of a dispersion sample with a transmission light microscope at 500-fold magnification allows a quick characterization of the dispersion quality, since coarse particles can be easily detected (Figure 17). Further valu-

able information on the dispersion quality and particle size distribution can be obtained by static laser light scattering measurements.

Figure 17

Light Microscopy Images of good (left) and poor (right) Carbon Black Dispersion.

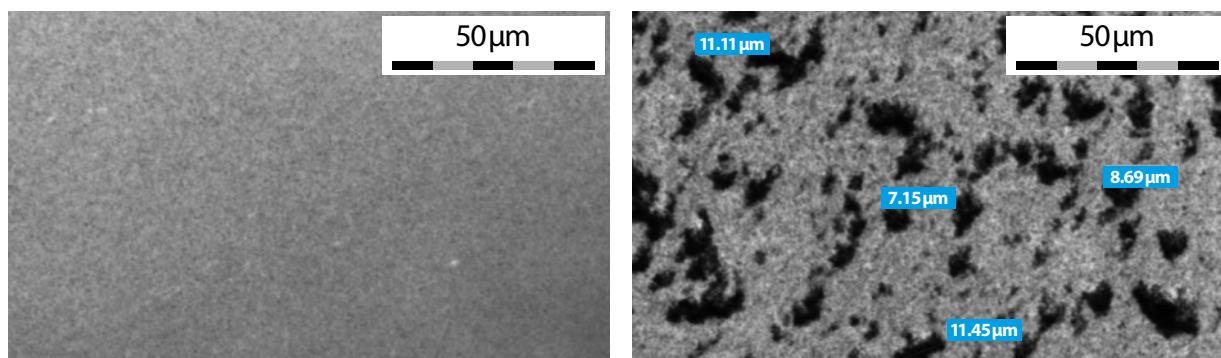

Filtration can be used as an efficient, practical, application-related test to determine the dispersibility of Specialty Carbon Black. The filtrate volume of a Specialty Carbon Black dispersion (diluted to 5% pigment content) at a

defined pressure is measured. The amount of filtrate strongly depends on the concentration of coarse particles in the dispersion.

5.2 Storage Stability

Several stability test methods are usual to determine the dispersibility of Specialty Carbon Black dispersions and final pigmented inkjet ink. Common methods include:

- Zeta potential measurement to determine the surface charge as a function of pH
- Stability tests at elevated temperatures to simulate the long-term stability at room temperature
- Freeze-thaw-stability
- Determination of sedimentation profiles by Brookfield Viscometer with a Helipath attachment (**Figure 18**)
- Determination of coarse particles content by particle size analyzers

Long term stability tests are an essential attribute for the dispersibility of pigment concentrates and final inkjet inks. Stability testing is conducted on the undiluted dispersion samples at various elevated temperatures over several weeks. Beside particle size distribution profiles the critical elements are rheological properties, pH stability and sedimentation tendency.

A relevant measurement to determine the stability of Specialty Carbon Black dispersions is the use of a Brookfield viscosimeter with a Helipath attachment. After completing a set storage time at defined conditions, the Brookfield spindle is immersed into the dispersion. The spindle is moved with the Helipath attachment from top to bottom of the flask and back to the starting position with 50 viscosity values being measured during this movement. Viscosity fluctuation between the 50 measuring points is a sign of instability or sedimentation tendency.

Figure 18

Sedimentation Profile of Specialty Carbon Black Dispersion based on NIPex® 160 IQ after storage for 35 days at 50 °C

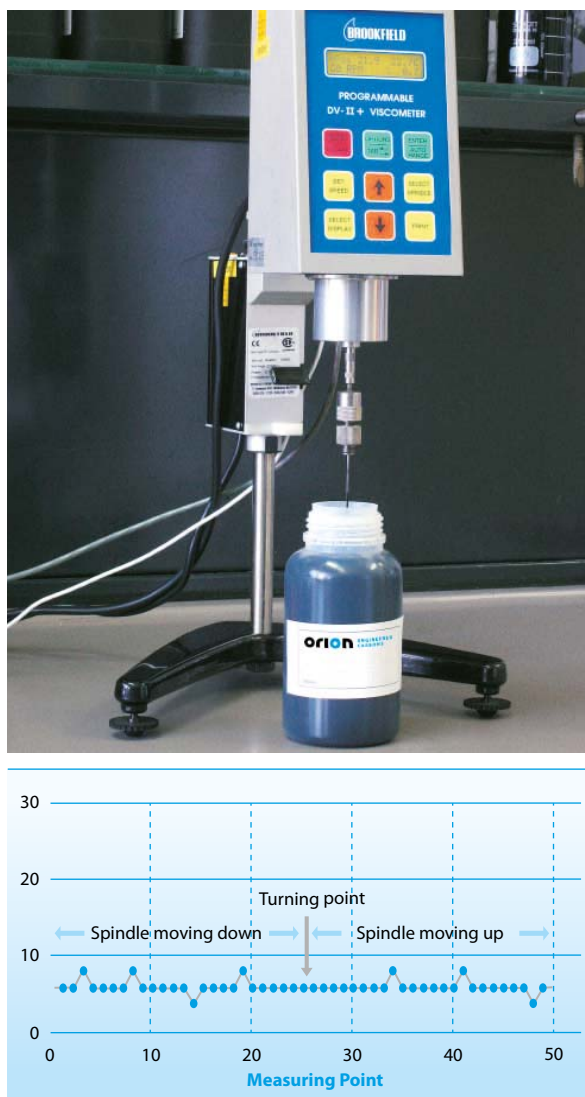

5.3 Optical Density

Optical density of pigmented inkjet inks on coated papers is primarily obtained by the quality of the paper coating. The paper coating guarantees that the pigment particles build a pigment layer on the paper surface which develops the high optical density. This situation is different for uncoated papers as the finely dispersed Specialty Carbon Black particles can penetrate into the paper pores, decreasing the optical density of the printed text or image. Preventing penetration into uncoated paper is the challenge for ink formulators. Additionally, inkjet inks containing additives with good wetting properties such as dispersants, accelerate the pigment penetration as soon as the inkjet ink is fired onto the paper surface. The result is lower optical densities.

Therefore the selection of Specialty Carbon Black which are easily dispersed is essential to reduce or eliminate wetting agents such as dispersants. A portfolio of oxidized Specialty Carbon Black grades is currently being developed to help customers to meet these needs. Lab tests with model inks, formulated with 3-5 weight % pigment content, are applied to different inkjet and plain papers at a thickness of 6 μm (Figure 19). After drying, the optical density of these draw-downs is determined with a commercial spectral photometer.

The following parameters are known to have a significant effect on the resulting optical density values from a Specialty Carbon Black preparation:

- Choice of pigment
- Pigment loading
- Choice of dispersants
- Substrate
- Inkjet ink composition

The critical Specialty Carbon Black properties to consider for obtaining high optical density values are:

- High structure (OAN >90 ml/100 g)
- Fine primary particle size (≤ 20 nm)
- High porosity
- Network-like reagglomeration on the substrate surfaces (see chapter 3.1)

Figure 19

Creation of Ink Draw-downs with a Control Coater from Erichsen GmbH for the Determination of the optical Density

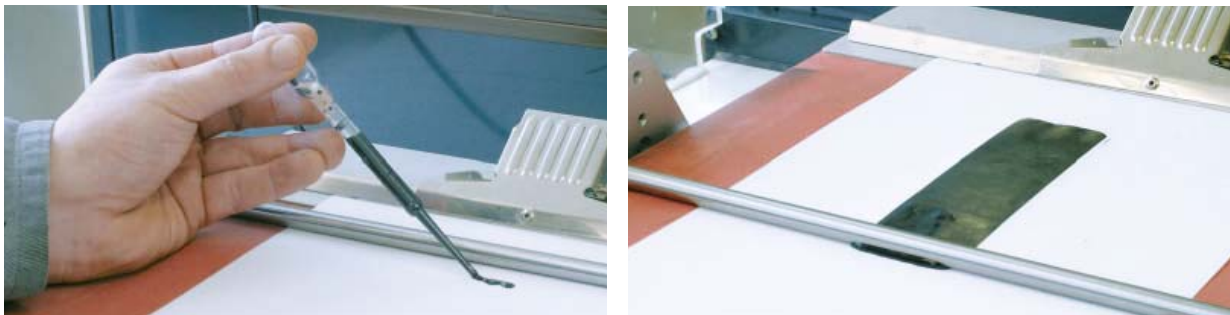

Another critical component of an inkjet ink is the choice of dispersant to meet the demands of a modern inkjet printing system (see Chapter 4). While thousands of dispersants are available, only few of them can be used in inkjet inks without decreasing print reliability and image performance. Several patents report using dyes as effective dispersants to stabilize Specialty Carbon Black for inkjet inks, as well as using styrene acrylates or non-ionic dispersants with defined molecular weights.

Simply formulated Specialty Carbon Black dispersions based on NIPex® 160 IQ Gas Black and dispersants in de-ionized water demonstrate the key role of dispersant, Specialty Carbon Black loading and substrate (see Table 3).

Table 3

Test Inkjet Ink Formulation

Dispersion Sample No.		1	2	3
NIPex® 160 IQ	%	15.0	15.0	15.0
Dispersant A (based on dye)	%	1.2	–	–
Dispersant B (based on styrene acrylate)	%	–	14.0	–
Dispersant C (based on fatty alcohol ethoxylate)	%	–	–	10.0
2-Amino-2-Methyl-Propanol (90 wt. % aqueous solution)	%	–	–	0.3
De-ionized Water	%	83.8	71.0	74.7

Optical densities on 6 µm draw downs were determined for three dispersions diluted to 4.0% NIPex® 160 IQ weight content with de-ionized water.

The tremendous influence of the dispersant on the optical density is shown in Figure 20. Dispersion sample no. 3, containing a fatty alcohol ethoxylate based dispersant, results in poor optical density on all plain paper types. The result is due to the excellent wettability of this dispersant, preventing the agglomerate network to form and allowing the fine Carbon Black aggregates to penetrate into the pores of plain paper.

Figure 20

Influence of Dispersants and Substrate on the optical Density of Specialty Carbon Black Dispersions based on 4.0% NIPex® 160 IQ (compare to Table 3)

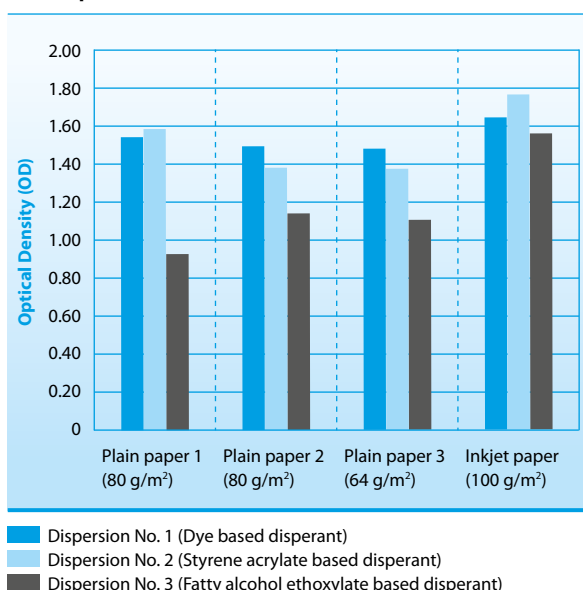

A combination of choosing the best Specialty Carbon Black, substrate and dispersant provides high optical density. This can be even further improved by the Specialty Carbon Black content as shown in Figure 21. Beside these key parameters, surface tension, viscosity, and ink additives offer further opportunities for achieving high optical density.

Figure 21

Influence of Carbon Black Content on the optical Density of Specialty Carbon Black Dispersion No. 2

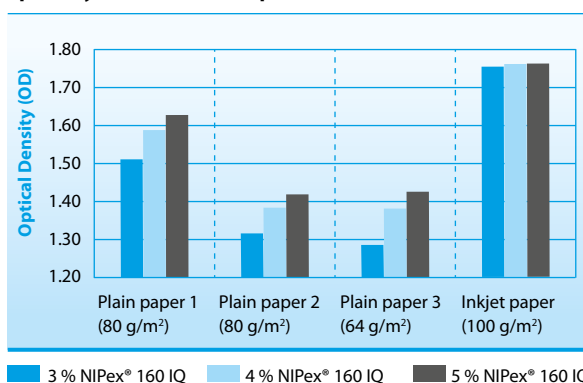

6 Product Safety

Our Specialty Carbon Blacks are used in a wide range of applications. It is therefore important to characterize the toxicological profile of Carbon Black and evaluate its safety with respect to human health and the environment.

Data generated for Carbon Black with regard to acute toxicity, eye and skin irritation, skin sensitization, genotoxicity, reproduction toxicity and specific target organ toxicity (STOT) do not provide cause for concern.

With regard to the carcinogenicity endpoint, Carbon Black has been classified by IARC as a category 2B carcinogen. This means that it is regarded as “possibly carcinogenic to humans”. In its conclusions, IARC determined that there was “sufficient evidence” from animal studies to conclude that Carbon Black is “possibly carcinogenic to humans” but that “there is inadequate evidence in humans for the carcinogenicity of Carbon Black”. This means that IARC’s classification is founded solely on experimental animal data. Indeed, the overall conclusion by IARC that Carbon Blacks is possibly carcinogenic to humans is predicated upon the observation that rats under extreme conditions developed lung tumors following repeated long-term exposure to Carbon Black. These tumors in rats develop under a condition termed by scientists as “lung overload”. Mice and hamsters subjected to equivalent treatment conditions as rats did not develop lung tumors in these experiments.

The scientific basis and relevance of data generated in rats for use in human risk assessment is therefore being challenged by many scientists. One important reason why effects seen in rats are considered not relevant for humans is because data obtained from human epidemiological studies do not show any evidence of a causal link between exposure to Carbon Black or similar dusts (like coal dust, toner and titanium dioxide) and lung cancer. It has been shown for example, that coal miners, known to have traditionally high coal dust exposures, do not develop “lung overload” and also do not have a higher lung cancer risk than the general population. More importantly, long-term investigations on large groups of workers in Carbon Black facilities in Germany, the UK and the USA show no evidence of a link between exposure to Carbon Black and higher lung cancer mortality rates. This evidence is in line with IARC’s determination that “there is inadequate evidence in humans for the carcinogenicity of Carbon Black”.

In conclusion, when handled in accordance with good housekeeping and safe workplace practices as outlined in our Safety Data Sheet, we believe that Carbon Black does not present a health hazard.

7 References

- Company Brochure “What is Carbon Black?”, Orion Engineered Carbons GmbH.
- Andreas Stübbe, Alfons Karl, Werner Kalbitz, “Investigation of the Application Properties of Carbon Blacks used in Pigmented Inkjet Inks”, IS&T and NIP 14: 1998 International Conference on Printing Technologies.
- Horst Ferch “Pigmentruße”, Degussa AG, 1995, Vincenz Verlag.
- Orion Engineered Carbon’s Technical Brochure “Specialty Carbon Blacks, Technical Data.”
- Technical Bulletin Fine Particles No. 81, “Pigment Carbon Black”, Orion Engineered Carbons GmbH.
- Thomas Lüthge, Gerd Tauber, Ralph McIntosh, Werner Kalbitz, Stephan Luedtke, “Self-Stabilizing Carbon Blacks: The Technological Advantages of Aqueous Inkjet Systems”, IS&T and NIP 20: 2004 International Conference on Printing Technologies.
- Mitchell, et al., “Process for making pigmented ink-jet inks”, U.S. Patent 5,026,427, issued 6/25/1991.
- M. Gore, “Homogenization process for ink-jet inks containing fine dispersions of pigments”, U.S. Patent 5,976,232, issued 11/2/1999.
- Stephen F. Pond, “Inkjet Technology and Product Development Strategies”, Torrey Pine Research, Carlsbad, CA (USA), 2000.
- “Aqueous, colloidal Gas Black suspension”, U.S. Patent 7,160,377 issued 01/19/2004.
- “Aqueous, colloidal Gas Black suspension”, U.S. Patent 7,005,004 issued 08/18/2005.
- “Aqueous, colloidal, freeze-resistant and storage-stable Gas Black suspension”, U.S. 2004087707 issued 05/06/2004.
- “Aqueous Carbon Black dispersion”, U.S. Patent 6,171,382 issued 01/05/2001.

ORION ENGINEERED CARBONS

Focused. Innovative. Responsive.

The Americas

Orion Engineered Carbons LLC
4501 Magnolia Cove Drive, Suite 106
Kingwood, TX 77345
USA
Phone +1 832 445 3300

AMERICAS@orioncarbons.com

Europe/ Middle East/ Africa

Orion Engineered Carbons GmbH
Hahnstraße 49
60528 Frankfurt am Main
Germany
Phone +49 69 36 50 54 100

EMEA@orioncarbons.com

Asia Pacific

Orion Engineered Carbons Trading (Shanghai) Co., Ltd.
BM Intercontinental Business Centre, Room 3701-3702
100 Yutong Road
200070 Shanghai, China
Phone +86 21 6107 0966

APAC@orioncarbons.com

Global Corporate Headquarters

Orion Engineered Carbons S.A., 6 Route de Trèves, L-2633 Senningerberg, Luxembourg, Phone +352 27 04 80 60

www.orioncarbons.com

All information and statements contained herein are believed to be accurate, however Orion Engineered Carbons GmbH (as well as all other Orion Engineered Carbons group companies including Orion Engineered Carbons SA), its agents and/or affiliates give no warranty with respect thereto, including but not limited to any results to be obtained or the non-infringement of any proprietary right. Use or application of such information or statements or the material or systems described herein is at user's sole discretion and risk, and consequently user acknowledges that Orion Engineered Carbons GmbH (as well as all other Orion Engineered Carbons group companies including Orion Engineered Carbons SA), its agents and/or affiliates shall bear no responsibility or liability for same. Nothing herein shall be construed as a license of or recommendation for use, especially with concern to the potential infringement of any proprietary right. All sales are subject to the respective Standard Terms & Conditions of Sale issued by Orion Engineered Carbons GmbH or - as the case may be - another Orion Engineered Carbons group company, including but not limited to the Limited Warranty clauses contained therein.

© 2017 Orion Engineered Carbons GmbH

OEC-TI 1291-02/2017